

INFO-SHEET

Steel Sheet Pile

SEP. 12



ArcelorMittal

GU 13N

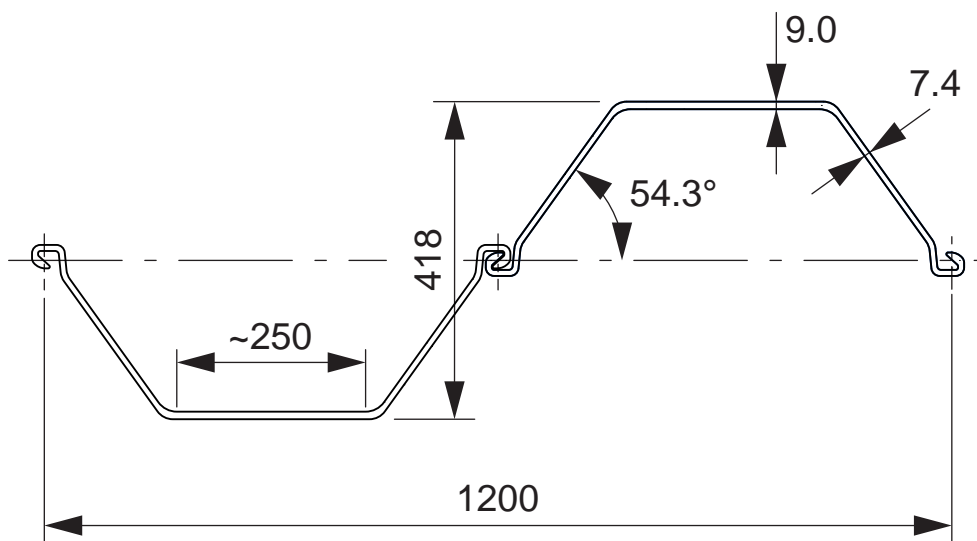

scale: 1/10

	Sectional area cm ²	Mass kg/m	Moment of inertia cm ⁴	Elastic section modulus cm ³	Plastic section modulus cm ³	Static moment cm ³	Radius of gyration cm	Coating area * m ² /m
Single Pile	76.3	59.9	5 440	395			8.44	0.85
Double Pile	152.6	119.8	31 900	1 525			14.46	1.69
Triple Pile	228.9	179.7	44 350	1 785			13.92	2.53
Per m of wall	127.2	99.8	26 590	1 270	1 535	755	14.46	1.41

ArcelorMittal reserves the right to change the section properties without prior notice

* 1 side, excluding inside of interlocks

ArcelorMittal Commercial RPS S.à r.l.
Sheet Piling
66, rue de Luxembourg
L-4221 Esch sur Alzette | Luxembourg

T +352 5313 3105
F +352 5313 3290
www.arcelormittal.com/sheetpiling
sheetpiling@arcelormittal.com

27.09.2012

FICHE D'INFORMATION

Palplanche

SEP. 12



ArcelorMittal

GU 13N

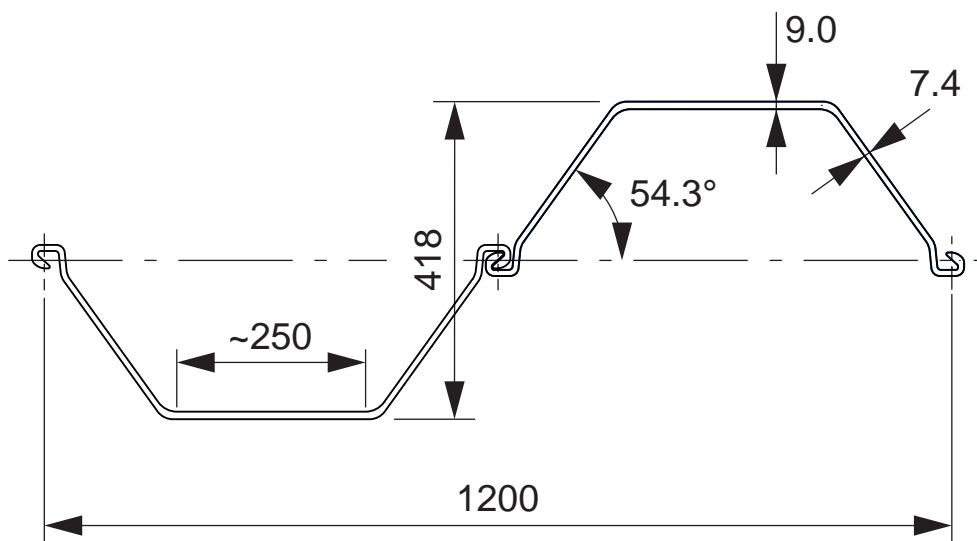

échelle: 1/10

	Section d'acier cm ²	Masse kg/m	Moment d'inertie cm ⁴	Module de flexion élastique cm ³	Module de flexion plastique cm ³	Moment statique cm ³	Rayon de giration cm	Surface à traiter * m ² /m
Palpl. simple	76.3	59.9	5 440	395			8.44	0.85
Palpl. double	152.6	119.8	31 900	1 525			14.46	1.69
Palpl. triple	228.9	179.7	44 350	1 785			13.92	2.53
Par ml de rideau	127.2	99.8	26 590	1 270	1 535	755	14.46	1.41

ArcelorMittal se réserve le droit de modifier les caractéristiques de ses profils sans préavis

* 1 côté, intérieur des serrures exclu

ArcelorMittal Commercial RPS S.à r.l.
Palplanches
66, rue de Luxembourg
L-4221 Esch sur Alzette | Luxembourg

T +352 5313 3105
F +352 5313 3290
www.arcelormittal.com/palplanches
palplanches@arcelormittal.com

27.09.2012

PROFILDATENBLATT

Spundwand

SEP. 12



ArcelorMittal

GU 13N

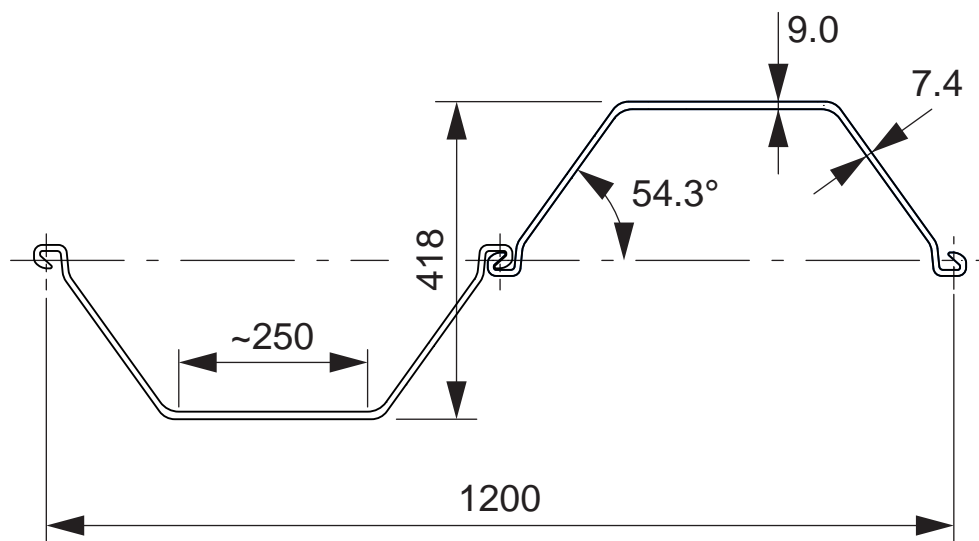

Masstab: 1/10

	Querschnittsfläche cm ²	Eigenlast kg/m	Trägheitsmoment cm ⁴	Elastisches Widerstandsmoment cm ³	Plastisches Widerstandsmoment cm ³	Statisches Moment cm ³	Trägheitshalbmesser cm	Anstrichfläche * m ² /m
Einzelbohle	76.3	59.9	5 440	395			8.44	0.85
Doppelbohle	152.6	119.8	31 900	1 525			14.46	1.69
Dreifachbohle	228.9	179.7	44 350	1 785			13.92	2.53
Je m Wand	127.2	99.8	26 590	1 270	1 535	755	14.46	1.41

ArcelorMittal behält sich das Recht vor, die geometrischen Profileigenschaften ohne vorherige Ankündigung zu ändern

* 1 Seite, ohne Schlossinneres

KARTA KATALOGOWA

Grodzica

wrzesień 12



ArcelorMittal

GU 13N

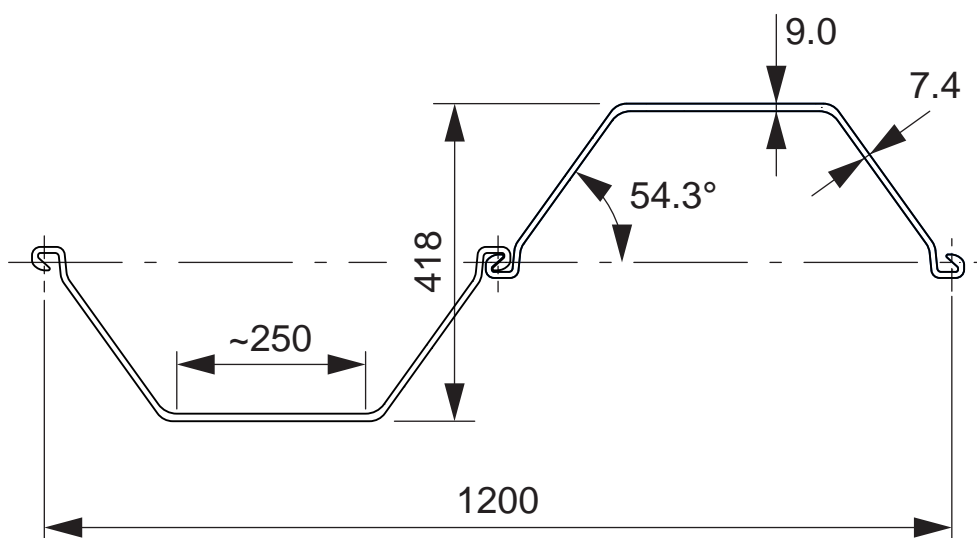

skala: 1/10

	Przekrój poprzeczny cm ²	Ciężar kg/m	Moment bezwładności cm ⁴	Sprężysty wskaźnik wytrzymałości cm ³	Plastyczny wskaźnik wytrzymałości cm ³	Moment statyczny cm ³	Promień bezwładności cm	Powierzchnia malowania * m ² /m
Pojedyncza grodzica	76.3	59.9	5 440	395			8.44	0.85
Podwójna grodzica	152.6	119.8	31 900	1 525			14.46	1.69
Potrójna grodzica	228.9	179.7	44 350	1 785			13.92	2.53
Metr bieżący ściany	127.2	99.8	26 590	1 270	1 535	755	14.46	1.41

ArcelorMittal zastrzega sobie prawo do zmiany właściwości przekroju bez wcześniejszego powiadomienia

* jednostronnie, z wyłączeniem wnętrza zamków

ArcelorMittal Commercial Long Polska Sp. z o.o.
Grodzice
Al. J. Piłsudskiego 92
41-308 Dąbrowa Gómicza | Polska

T +48 32 776 67 95 | F +48 32 776 82 11
M +48 600 977 577

www.arcelormittal.com/sheetpiling | www.grodzice.pl
sheetpiling@arcelormittal.com

27.09.2012

INFO-SHEET

Steel Sheet Pile

SEP. 12



ArcelorMittal

GU 13N

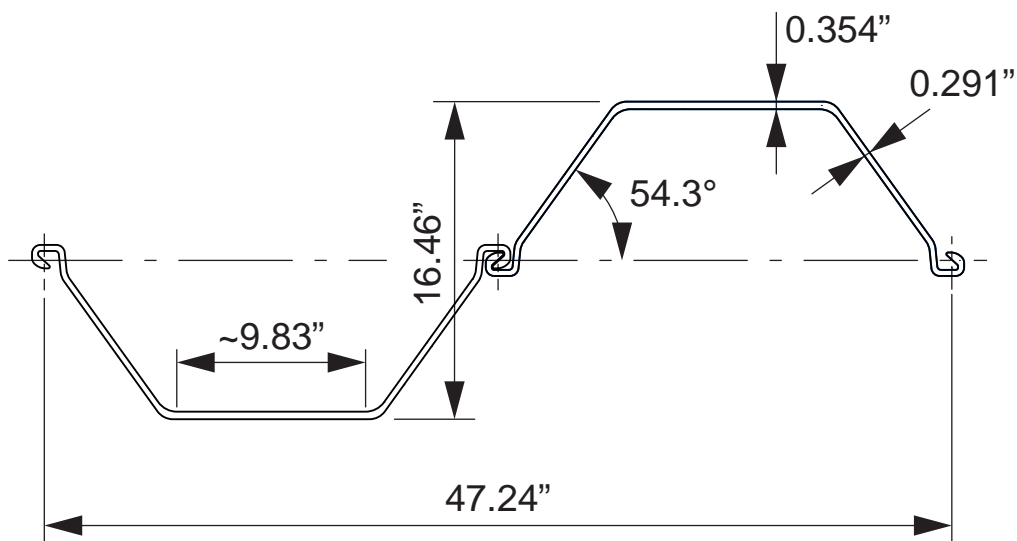

scale: 1/10

	Sectional area in ²	Mass lb/ft	Moment of inertia in ⁴	Elastic section modulus in ³	Plastic section modulus in ³	Static moment in ³	Radius of gyration in	Coating area * ft ² /ft
Single Pile	11.83	40.24	130.7	24.1			3.32	2.79
Double Pile	23.65	80.49	766.5	93.1			5.69	5.54
Triple Pile	35.48	120.73	1 065.5	109.1			5.48	8.30
Per ft of wall	6.01	20.44	194.7	23.7	28.6	14.0	5.69	1.41

ArcelorMittal reserves the right to change the section properties without prior notice

* 1 side, excluding inside of interlocks

ArcelorMittal Commercial RPS S.à r.l.
 Sheet Piling
 66, rue de Luxembourg
 L-4221 Esch sur Alzette | Luxembourg

T +352 5313 3105
 F +352 5313 3290
www.arcelormittal.com/sheetpiling
sheetpiling@arcelormittal.com

27.09.2012